

*Signature Series*

Maximum Resilience Broadcast Audio



*DDA1:6*

## **Digital Distribution Amplifier**

1 in 6 out AES3 (Stereo) with headphone monitor  
up to 192kS/s

*User Guide*

### **Glensound**

6 Brooks Place, Maidstone  
Kent, UK, ME14 1HE  
Tel: +44 (0)1622 753662  
[www.glensound.co.uk](http://www.glensound.co.uk)





# GlenSound Electronics Ltd

Thank you for choosing a new GlenSound product.

All rights reserved.

Information contained in this manual is subject to change without notice, if in doubt please contact us for the latest product information.

If you need any help with the product then we can be contacted at:

GlenSound Electronics Ltd  
1 – 6 Brooks Place  
Maidstone  
Kent  
ME14 1HE  
United Kingdom

Telephone: +44 (0) 1622 753662

Fax: +44 (0) 1622 762330

## EMAIL ADDRESSES

General enquires: [office@glenSound.co.uk](mailto:office@glenSound.co.uk)

Technical enquires: [techinfo@glenSound.co.uk](mailto:techinfo@glenSound.co.uk)

Sales enquires: [sales@glenSound.co.uk](mailto:sales@glenSound.co.uk)



## IMPORTANT SAFETY INSTRUCTIONS

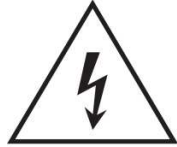

This symbol is intended to warn that dangerous voltages within the product are present and constitute a risk of electric shock.



This symbol is intended to highlight that there are important operating & maintenance instructions in the literature accompanying this unit.

- 1) Read these instructions
- 2) Keep these instructions
- 3) Heed all warnings
- 4) Follow all instructions
- 5) Do not use this apparatus near water
- 6) Clean only with a dry cloth
- 7) Do not block any ventilation openings. Install in accordance with manufacturer's instructions
- 8) Do not install near any heat sources such as radiators, heat registers, stoves, or other apparatus (including amplifiers) that produce heat
- 9) Do not defeat the safety purpose of the polarized or grounding type plug. A polarized plug has 2 blades with one wider than the other. A grounding type plug has 2 blades and third grounding prong. The wider blade or the 3<sup>rd</sup> prong are provided for your safety. If the provided plug does not fit into your outlet, consult an electrician for replacement of the obsolete outlet
- 10) Protect the power cord from being walked on or pinched, particularly at plugs, convenience receptacles and the point where they exit from the apparatus
- 11) Only use attachments/ accessories specified/ supplied by the manufacturer



- 12) Use only with the cart, stand, tripod, bracket, or table specified by the manufacturer, or sold with the apparatus. When a cart is used, use caution when moving the cart/ apparatus combination to avoid injury from tip over
- 13) Unplug this apparatus during lightning storms or when unused for long periods of time
- 14) Refer all servicing to qualified service personnel. Servicing is required when the apparatus has been damaged in any way, such as power supply cord or plug is damaged, liquid has been spilled or objects have fallen into the apparatus, the apparatus has been exposed to rain or moisture, does not operate normally, or has been dropped
- 15) Do not attempt to modify this product. Doing so could result in personal injury and/ or product failure

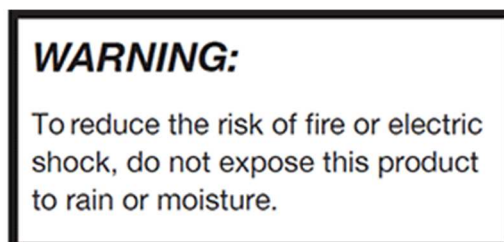
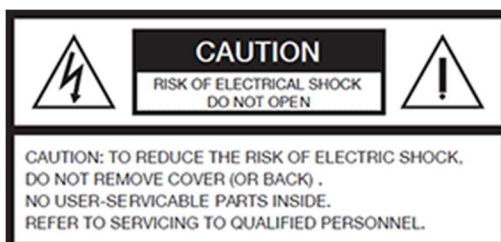



### **IMPORTANT: MAINS PLUG WIRING INSTRUCTIONS**

This Signature unit is supplied with a moulded mains plug fitted to the AC mains lead.

Mains wiring colours/ connections:

The Green/ Yellow or Green wire must be connected to the terminal in the plug marked 'E' or with the Earth Symbol.

The Blue or Black wire must be connected to the terminal in the plug marked 'N' (Neutral).

The Red or Brown wire must be connected to the terminal in the plug marked 'L' (Live).



**THIS UNIT MUST BE EARTHED**



**THIS UNIT IS FITTED WITH AN INTERNAL MAINS FUSE.**

The fuse is located internally between the Live terminal of the IEC plug and the Live input of the power supply. The fuse should only be changed by a qualified service engineer. If replacing the fuse care should be taken to fit a correctly rated replacement. The fuse rating can be found in the technical specifications page of this handbook.



This equipment manufactured by GlenSound Electronics Ltd of Brooks Place  
Maidstone Kent ME14 1HE is  marked and conforms to:

Low Voltage Directive: EN60065

Emissions: EN55103.1

Immunity: EN55103.2

## **WASTE ELECTRICAL AND ELECTRONIC EQUIPMENT REGULATIONS 2006 (WEEE)**

GlenSound Electronics Ltd is registered for business to business sales of WEEE in  
the UK our registration number is:

WEE/JJ0074UR

## **RoHS2 DIRECTIVE**

EC directive 2011/65/EU restricts the use of the hazardous substances listed below  
in electrical and electronic equipment.

This product conforms to the above directive and for this purposes, the maximum  
concentration values of the restricted substances by weight in homogenous  
materials are:

Lead	0.1%
Mercury	0.1%
Hexavalent Chromium	0.1%
Polybrominated Biphenyls	0.1%
Polybrominated Diphenyl Ethers	0.1%
Cadmium	0.01%

## **PRODUCT WARRANTY:**

All equipment is fully tested before dispatch and carefully designed to provide you with trouble free use for many years.

We have a policy of supporting products for as long as possible and guarantee to be able to support your product for a minimum of 10 years.

For a period of one year after the goods have been despatched the Company will guarantee the goods against any defect developing after proper use providing such defects arise solely from faulty materials or workmanship and that the Customer shall return the goods to the Company's works or their local dealer.

All non-wear parts are guaranteed for 2 years after despatch and any defect developing after proper use from faulty materials or workmanship will be repaired under this warranty providing the Customer returns the goods to the Company's works or their local dealer.



**DDA1:6 Digital AES3 Distribution Amplifier**  
**Handbook Contents**

Issue 1,

Description

Page No.

**Contents**

IMPORTANT SAFETY INSTRUCTIONS..... 3

PRODUCT WARRANTY:..... 6

OVERVIEW ..... 8

PHYSICAL INSTALLATION ..... 9

AUDIO BLOCK DIAGRAM ..... 11

EXAMPLES OF USE..... 12

    1. Radio Station CTA..... 12

USER CONTROLS..... 13

    1. Power On LED..... 13

    2. Error LED..... 13

    3. AES Lock LED ..... 13

    4. Selector Switch ..... 13

    5. Headphone Jack Socket..... 13

    6. Headphone Volume Control ..... 13

CONNECTIONS..... 14

    7. AES3 Outputs..... 14

    8. AES3 Input..... 14

    9. External DC Input ..... 14

    10. Mains In..... 14

WIRING INFORMATION ..... 15

    1. Standard Pin Outs..... 15

TECHNICAL SPECIFICATION..... 16



## **OVERVIEW**

The GlenSound Signature Series DDA1:6 is a professional audio distribution amplifier. It is manufactured using high quality components and low noise audio circuits to provide many years of trouble free use.

Although traditionally a broadcast manufacturer, GlenSound's products are equally at home in professional and high end home studios, industrial installations and live pro sound environments. The DDA1:6 can therefore be used in a number of applications.

The DDA1:6 features one transformer balanced audio inputs on a Neutrik XLR. This input is then routed via the front panel 'Loop Through' or 'Renormalising' switch to 6 transformer balanced outputs also on Neutrik XLRs.

When in 'Loop Through' mode the AES3 input is sent straight to the 6 off AES3 outputs and the signal present at the output will be identical to that received by the input. Loop through is done with no delay to the signal and therefore is most useful if the AES3 signal is synced with another source through the users' production chain.

When in 'Renormalising' mode (the most common way to use the unit), the incoming signal is cleaned up and the output signals will have clean clock edges and be as close to their initial source as possible. The only disadvantage of renormalising is that the incoming signal is fed via a high quality AES3 receiver chip and it takes 1 sample to produce the cleaned up output.

The DDA1:6 works with all digital signals from 16 – 192 kS/s and up to 32 bit.

The DDA1:6 is powered from an internal switch mode mains power supply fed from a filtered IEC mains plug suitable for use Worldwide. It has an internal fuse for safety. The unit can also alternatively be powered from an external +/-12V DC power source (such as the Signature Series PS1). If both mains and external DC power sources are present then, if one power source were to fail the unit would continue to work seamlessly from the other source.



## **PHYSICAL INSTALLATION**

The GlenSound Signature Series have been designed to be highly versatile for installation and can be installed in 19" racks with either their front or rear panels facing the front of the rack. They can also be mounted underneath desks or work tops and can be either permanently mounted or stood (using the supplied feet) on top of desks or worktops.

### **INSTALLING SIGNATURE SERIES IN A 19" RACK**

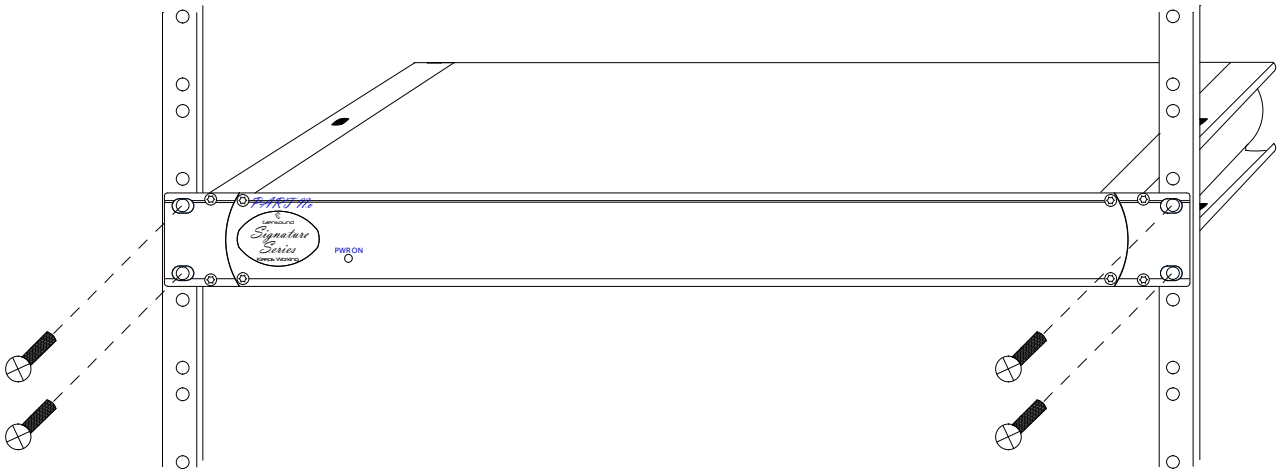

Firmly hold the signature subrack within the 19" rack and locate in 1RU of space. Use the supplied 6mm rack screws to securely attach the unit to the rack.

### **INSTALLING ADHISIVE FEET FOR NON PERMANENT TABLE TOP MOUNTING**



Remove the front rack ears (if they are not required), turn the unit upside down and attach the supplied 4 sticky feet as per the above drawing.

## **SWAPPING RACK EARS TO ALLOW THE REAR TO BE INSTALLED AT THE FRONT OF A RACK**

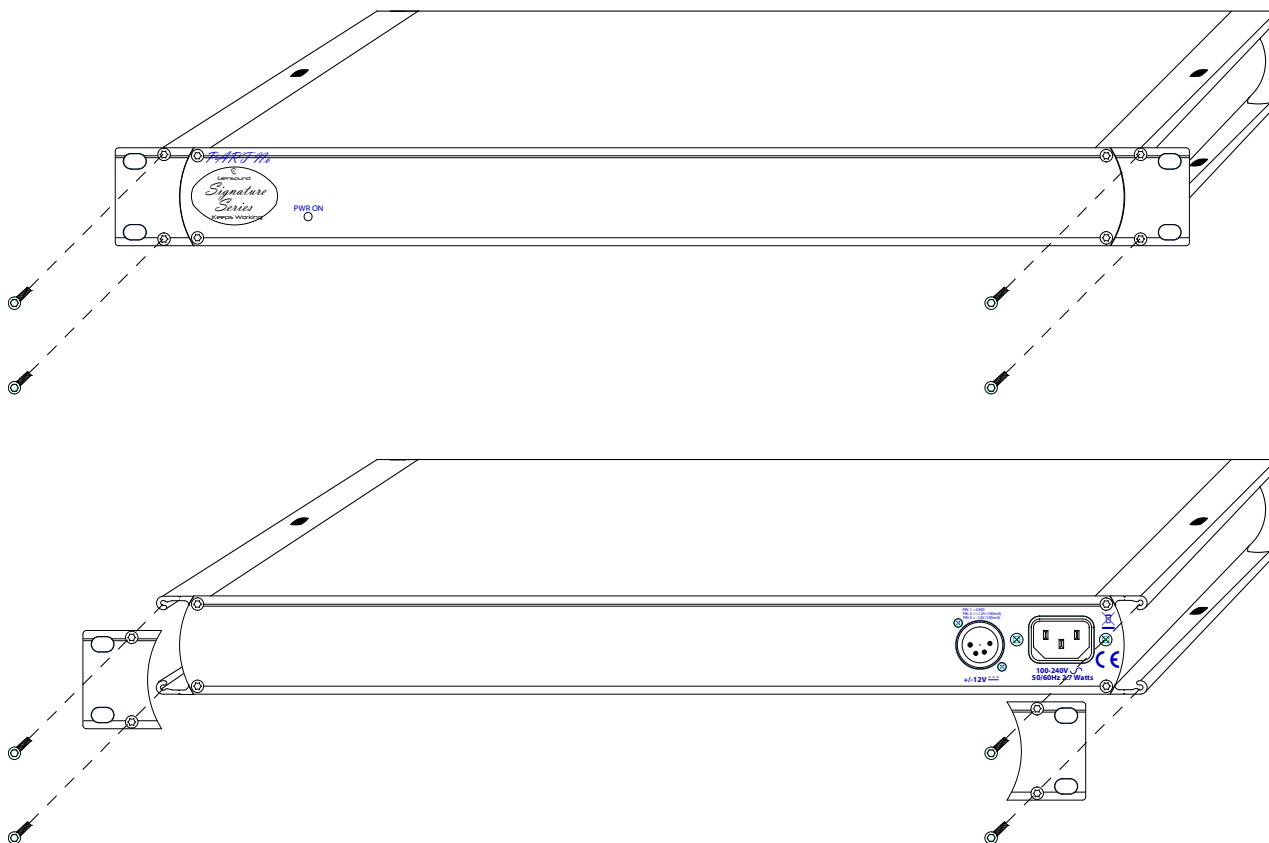

First remove the 4 silver button head screws that fix the rack ears onto the front of the unit as shown in the top picture above.

Remove the rack ears and turn the unit around for access to its back panel.

Re-fit the 2 rack ears using the same 4 silver button head screws that were removed from the front as per the bottom picture above.

## **USING THE MOUNTING HOLES FOR PERMANENTLY ATTACHING THE UNIT ABOVE OR BELOW A WORKTOP/ DESK**

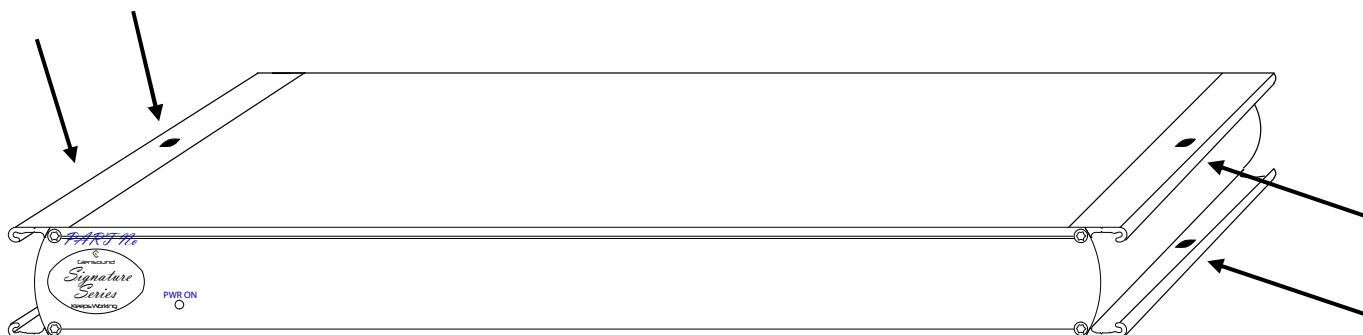

Use either the top or bottom mounting holes as indicated above to use suitable screws to attach the signature unit to a worktop or bench. **\*\*PLEASE ENSURE THAT YOU USE SUITABLE FIXINGS\*\***

# AUDIO BLOCK DIAGRAM

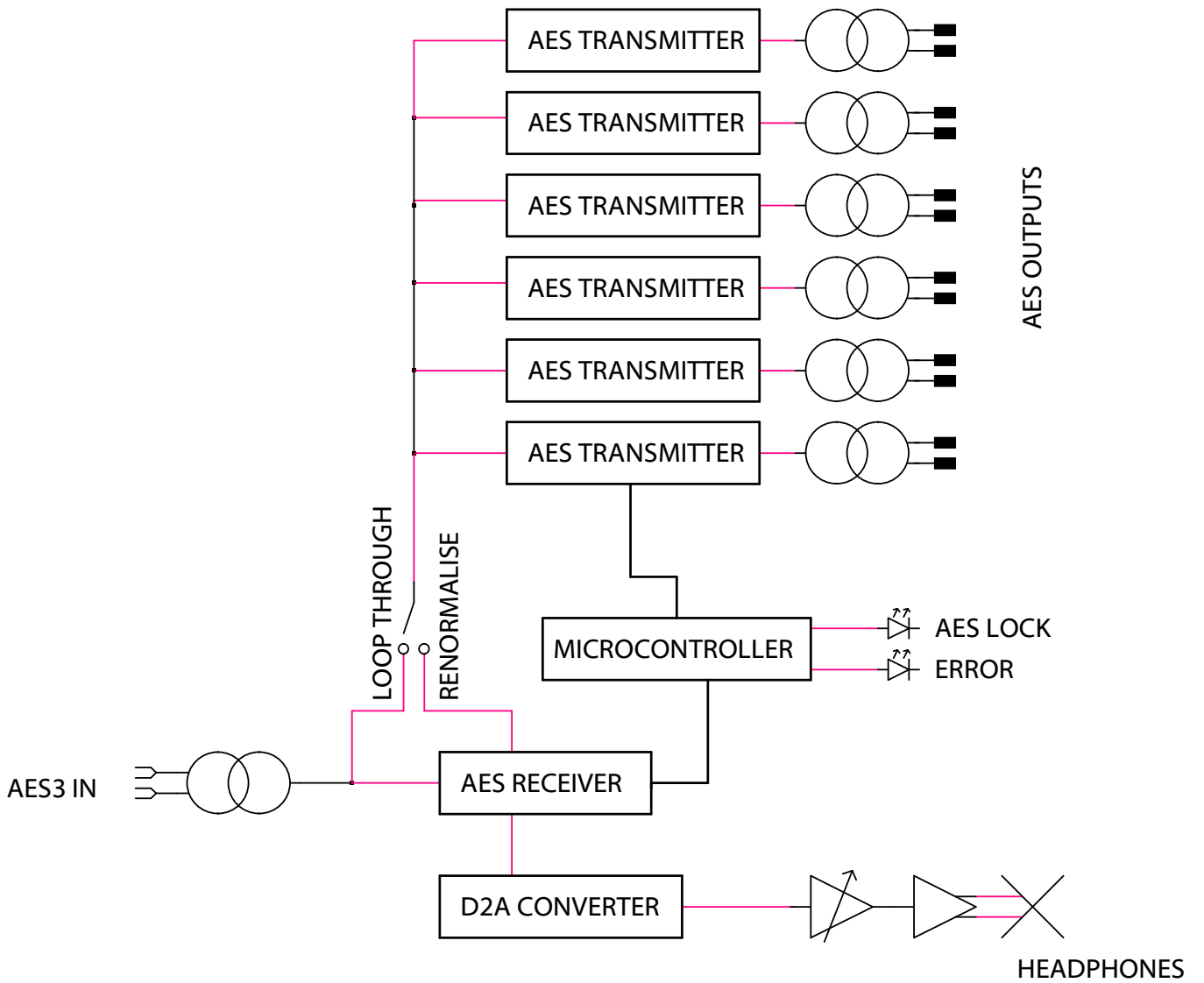
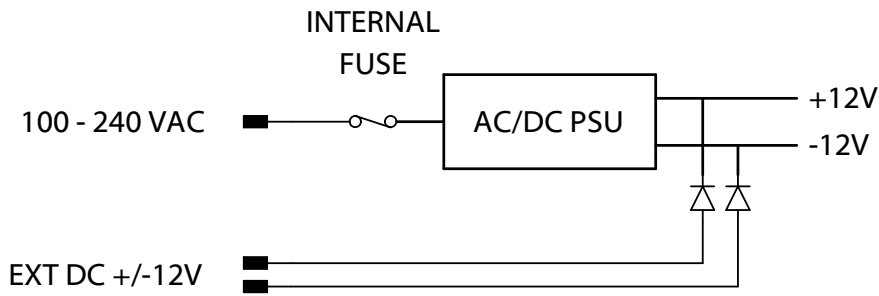

## EXAMPLES OF USE

### 1. Radio Station CTA

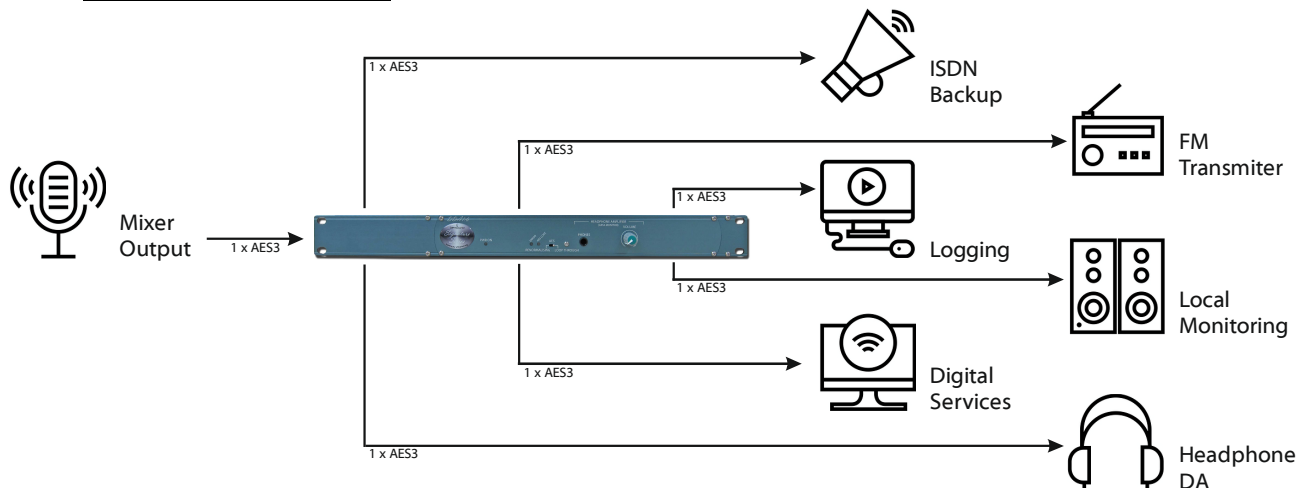

In this example, the main stereo programme feed from a radio station needs to be distributed across multiple platforms. The output from the desk or automation system no longer just heads off to the transmitter. The audio must be distributed across all of the relevant services that require a connection of the original programme audio.

The Signature DDA 1:6 provides 6 stereo AES outputs of the main AES programme audio. One output connects to the transmitter as the main FM broadcast feed. As multiple guest headphones are required in the studio, another output connects to a separate AES headphone distribution amplifier. This station also broadcasts online, so another output connects to a PC to become the internet broadcast stream. Local monitoring is required, so one feed goes to the local AES monitoring system. The transmitter B chain is on ISDN, so one AES output goes to an ISDN codec. And the final output connects to another PC that manages all of the stations logging requirements.

It's very easy to see why multiple outputs of the main AES programme audio are required in a typical radio station environment.

## USER CONTROLS

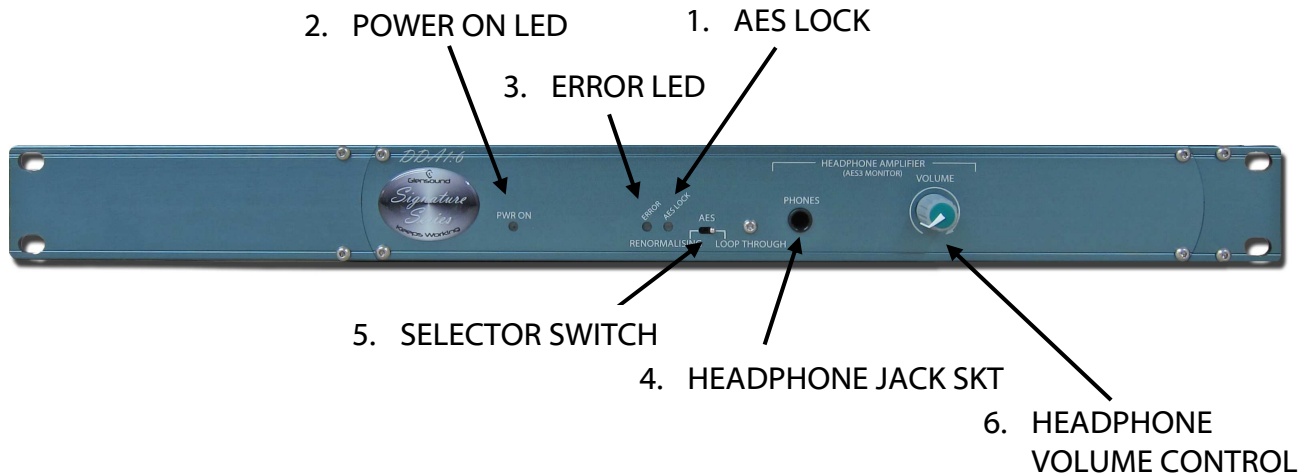

### **1. Power On LED**

The front panel bright blue LED shows that the unit is powered on and functioning correctly.

### **2. Error LED**

The error LED is fed from the output of the AES3 receiver and will be illuminated whenever the receiver is not receiving a valid AES3 signal.

### **3. AES Lock LED**

This LED is connected to the output of the AES3 receiver. If illuminated it indicates that the receiver has detected a valid AES3 signal and is correctly locked onto it.

### **4. Selector Switch**

When in the 'Renormalising' position the AES3 outputs of the unit will be cleaned up and 'renormalised' so as they have clear sharp clock edges and mirror the original AES3 signal. It takes 1 sample to do this so the output will be sample behind the input.

When in 'Loop Through' mode the AES3 outputs will be identical to the input, so if the input signal has been degraded by a long cable run or noise, then the output signal will reflect this identically.

### **5. Headphone Jack Socket**

This is a standard 6.35mm (1/4") stereo headphone jack socket. The audio output is taken from the AES3 input and it can be used as a monitor point to ascertain audibly the quality of the incoming circuit.

### **6. Headphone Volume Control**

Turning this control clockwise will increase the audio output level of the headphone amplifier.

## CONNECTIONS

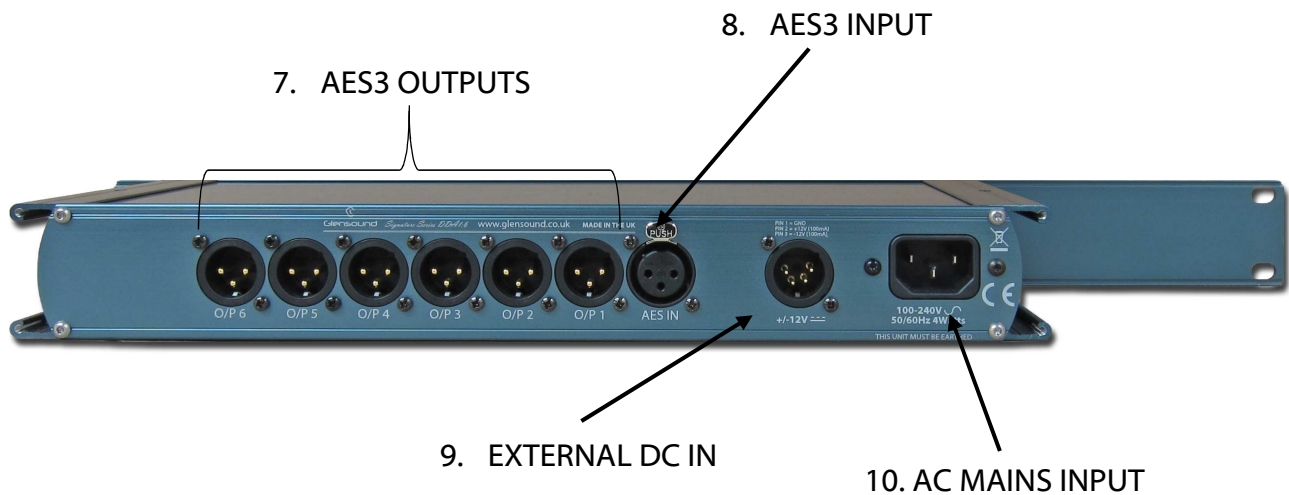

### **7. AES3 Outputs**

6 off identical transformer balanced AES3 outputs, derived from the AES input and matching its frequency rate.

### **8. AES3 Input**

This transformer balanced AES3 input will accept standard AES3 signals between 16 and 192kS/s and up to 32 bit.

### **9. External DC Input**

This DC input can be used instead or as well as the mains input. It requires a +/- 12V power source (such as our PS1). If used in conjunction with the mains input it will seamlessly provide a redundant power source.

### **10. Mains In**

This AC input accepts a wide range power supply, suitable for use Worldwide. If used in conjunction with the external DC supply then a seamless redundant power supply will be provided.



## WIRING INFORMATION

### 1. Standard Pin Outs

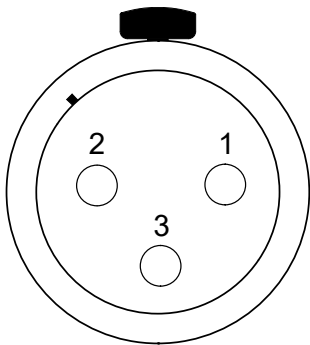

XLR SOCKET (FEMALE)

#### STANDARD XLR AUDIO PINOUTS:

- 1: Ground/ Earth
- 2: INPHASE/ POSITIVE/ MIC +
- 3: MATE/ NEGATIVE/ MIC -

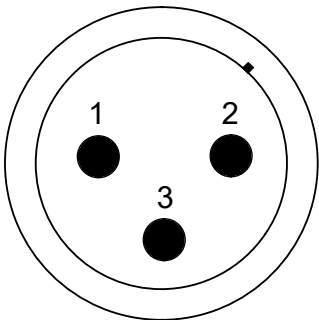

XLR PLUG (MALE)

#### STANDARD HEADPHONE WIRING:

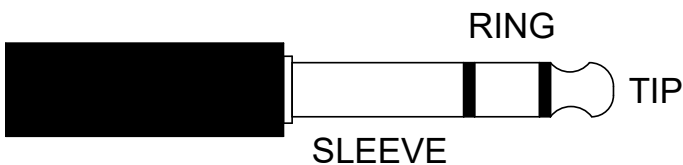

- TIP: A/ LEFT Ear
- RING: B/ RIGHT Ear
- SLEEVE: Common/ Earth

#### HEADPHONE WIRING NOTE:

The *Signature Series* range of products feature sophisticated headphone amplifiers whose stereo outputs can be connected directly to mono headphone jacks without damaging the headphones internal amplifiers.



## TECHNICAL SPECIFICATION

### AUDIO AES3 IN to OUT

**Input Impedance**

110 ohms

**Output Impedance**

110 ohms

**Maximum & Minimum Levels**

200mV to 10V peak to peak

**Sample Frequency Range**

32-192 kS/s (32, 44.1, 48, 88.2, 96, 176.4, 192 kS/s)

**Digital Resolution**

8, 16, 24 or 32 bit

**Input Type**

1 x 3 pin Neutrik XLR Transformer balanced

**Output Types**

6 x 3 pin Neutrik XLRs Transformer balanced

**Noise (unweighted 22Hz-22kHz)**

-145.7dBfs

**Distortion (+8 from line up)**

0.00005%

**Loop Through**

Output signal integrity matches input signal

**Re-normalised**

Output signal is reconstituted and signal integrity returned to normal

### HEADPHONE MONITORING

**Headphone Level**

0dB (600 Ohms) @ -18dBfs input

**Headphone Gain Range**

+6dBu to off

**Headphone Clip Level**

+18dBu

**Frequency Response (@96kS/s)**

25Hz: -0.25dBu

32kHz: 0.25dBu

**Noise Level (Unweighted 22Hz-22kHz)**

-77dBu @ Maximum gain

**Distortion (+8 from line up)**

100Hz: 0.006%

1kHz: 0.005%

10kHz: 0.011%

### PHYSICAL

**Size**

336 x 123 x 44mm (LxDxH) no rack ears

482mm 19" (1RU) with rack ears

**Weight**

0.75kg

**Mechanics**

All aluminium construction, anodized and laser etched

**Shipping Carton**

Rugged export quality cardboard carton

610 x 420 x 130mm LxDxH

**Shipping Weight**

2.25kg

### POWER

**Mains Input**

Filtered IEC, 100 to 240VAC

47 - 63Hz

**AC Consumption**

1.4 Watts @ 230VAC

**DC Input**

4 Pin Neutrik XLR plug +/- 12V

**DC Consumption**

<60mA per rail

**Internal Mains Fuse**

20mm 1A Anti Surge